

Mobile Stander

Mobile Stander

K110, K130, K150 & K170 Product Manual





Contents

Safety messages and important information	3
Recommended use and item dimensions	4
Check your order	4
Basic components	5
Components	
Sandals & wedges	6
Additional seat pads and large wheels	7
Arm prompts with mounting bracket	8-9
Hand loops with mounting bracket	10
Communication tray mounting bracket	11-12
Operation	13
Maintenance, cleaning, and warranty	14
Materials and user modifications	15

Key for users

Use this key to determine which sections of this product manual apply to you.

 **Technical Users** For professionals who order and set up Rifton products.

 **Home Users** For care-givers who use Rifton products on a regular basis.

 **Maintenance Personnel** For anyone who is responsible for service or re-ordering of Rifton products and parts.

WARNING



- Thoroughly read and understand the information in this product manual before attempting to use this product. If the procedures and instructions in this product manual are not followed, serious injury or death could occur.
- A qualified professional must assess the appropriateness and safety of all equipment for each user.
- This product is intended for use by clients of unreliable judgment. Adult supervision is required at all times.
- To prevent falls and injuries:
 - Do not use this product on rough and uneven terrain, around swimming pools, or near stairways.
 - Ensure the appropriate use of straps and supports at all times. Straps and supports are provided for the safety of the user and must be carefully adjusted for comfort and security.
 - Tighten all adjustment knobs before use and immediately after making any adjustments.
- Do not use this product for clients outside the height and weight limits specified in this manual.
- To prevent structural failure, which may result in serious injury or death:
 - Inspect this product and components regularly for loose or missing screws, metal fatigue, cracks, broken welds, missing attachments, general instability or other signs of excessive wear.
 - Immediately remove this product from use when any condition develops that might make operation unsafe.
 - Do not use Rifton components or products for any purpose other than their intended use.

IMPORTANT

Please save this product manual for future reference. Additional copies are available at <http://www.rifton.com/customer-service/product-manuals>.

Recommended use

The Mobile Stander is a Class 1 medical device. It is designed to help a person to stand. The straps, seat pad and contoured body support allow full to no weight-bearing by a user who has no active use of trunk and leg muscles.

The wide-standing platform helps the user to spread his or her legs for hip development and can accommodate leg braces.

User and item dimensions

User dimensions – inches (cm)	K110 mini	K130 small	K150 medium	K170 large
Height	25-32 (64-81)	30-40 (76-102)	37-52 (94-132)	48-65 (122-165)



Key user dimension: height

Select the appropriate Mobile Stander by the user's overall height. Choose the model that allows for growth.

Important: User's weight must not exceed the maximum working load.

Item dimensions – inches (cm)	K110 mini	K130 small	K150 medium	K170 large
Overall length and width	25 x 25 (64 x 64)	25 x 25½ (64 x 65)	32 x 29 (81 x 74)	39 x 33½ (99 x 85)
Overall height	22½-28 (57-71)	23½-30 (60-76)	31-39 (79-99)	37½-49 (95-124)
Width without big wheels	19½ (50)	24 (61)	25 (64)	28½ (72)
Wheel diameter	20 (51)	20 (51)	27 (69)	35 (89)
Width of body support	7-10 (18-25)	7-10 (18-25)	9-12 (23-30)	10-14 (25-36)
Height of body support	16½-22 (42-56)	22-29 (56-74)	29-38 (74-97)	36-48 (91-122)
Item weight – lbs (kg)	28 (13)	30 (14)	40 (18)	65 (29)
Max. working load – lbs (kg)	50 (23)	50 (23)	120 (54)	175 (79)

Check your order

Your Mobile Stander comes fully assembled.

If your shipment is incomplete or in any way damaged on arrival, please call Customer Service, 800.571.8198.

Basic item

Adjustments:

Figures 5a and 5b:

Always adjust body support height before a client is placed in the stander. Use knobs (A) to raise or lower body support and tighten both knobs securely.

1. Use four knobs (B) to adjust width of body support.
2. Top strap (C) can be adjusted and positioned at center of back underneath the arms, or behind the head to be used as a neck support.
3. The seat pad (D) can be adjusted up and down and angled in a variety of ways. Four separate straps (E) and multiple snap hook positions (F) allow for individualized positioning. By adjusting the position and angle of the seat pad, a client can be firmly supported in an upright standing position or in a flexed stance to allow for contractures of hips and knees. For more support a second seat pad can be placed in the middle of the back.
4. Knee straps (G) secure the knees in a standing or partially standing position. If a client needs abduction, two additional straps can be ordered. For a small child, use the top slots in the body support for the knee straps. For a larger person, use both bottom slots.
5. Optional large wheels can be removed using a simple push button. Rolling casters allow for convenient interaction between the client and his or her environment.

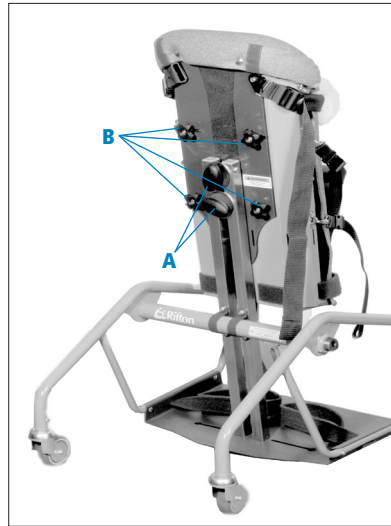

Figure 5a

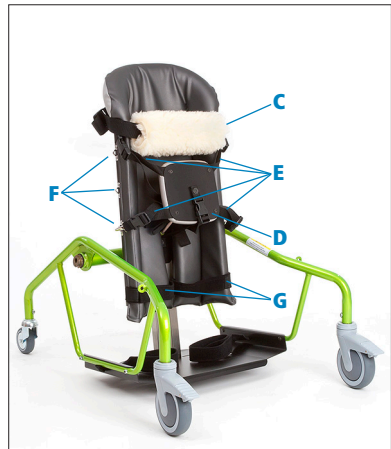

Figure 5b

Components

Sandals & wedges

Recommended use

Figure 6a: Sandals with wedges position and hold feet firmly on a wide platform to encourage standing.

Assembly:

Figure 6b:

1. Loosen both knobs (D) on the sandal. It has heel straps to the rear and adjustment knobs on the instep (see Diagram C).
2. Position sandal on platform and insert first bolt head into key slot (see Diagram A).
3. Rotate sandal to position and insert other bolt head into key slot (see Diagram B).
4. Rotate and/or slide sandal to desired position. Pull upwards on knobs while turning to tighten.

Adjustments:

1. Use knobs (D) to adjust sandal forward and back, side to side, and to desired foot angle on platform. Dual knob adjustment provides versatile foot positioning (see Figure 6a).
2. Wedges (E) can be used to elevate the toe or heel according to the client's needs. Hook on the bottom of wooden wedge adheres to loop dots on sandal, (F). If one of the client's legs is shorter two wedges can be combined and placed underneath the foot to raise it. To combine two wedges, the extra loop dots provided should be placed on face (E).

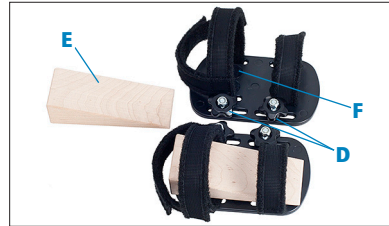

Figure 6a

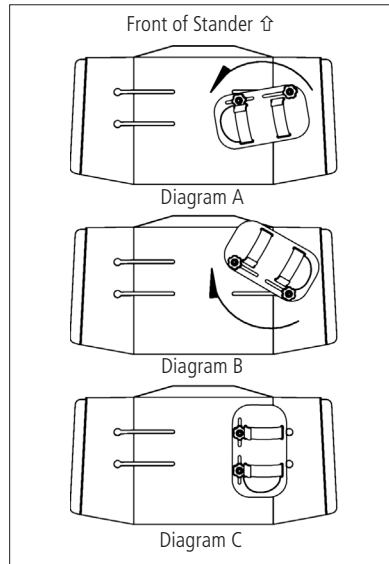

Figure 6b

Additional seat pads

K135 (small), K155 (large)

Recommended use

The K135 small and K155 large additional seat pads are designed for the K150 medium and K170 large Mobile Stander. Seat pads provide support for full weight-bearing and can be adjusted to accommodate all positions from sitting to standing.

Figure 7a:

Assembly:

1. Snap four snap-hooks (A) into metal loops (B) on body support.

Adjustments:

1. Adjust strap length by pulling or pushing end of strap through buckle (C).
2. Attach snap-hooks (A) to position a client in the stander. Release buckles (C) to remove the client from the stander.
3. To position seat pad at an angle, connect buckle in back of seat pad (D) to center strap on body support, and adjust strap length.



Figure 7a

Large wheels

Figure 7b: Large wheels with brakes pop on and off with the push of a button. Wheel locks (E) provide security, spoke guards protect fingers, and hand rims keep hands clean.

To remove the wheels from the frame, hold the wheel with both hands using the hand rim and the two holes in the spoke guard, and push the button in the center of the wheel with your thumb as shown.

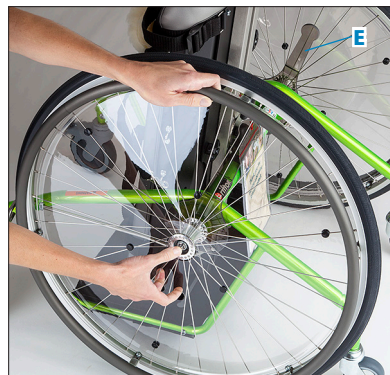

Figure 7b

Arm prompts with mounting bracket

Recommended use

NOTICE The mounting bracket is intended for use on the Rifton Mobile Stander only.

The arm prompts give additional support for a client with poor head and/or shoulder control. They stimulate the client to raise his/her head. The mounting bracket is needed to attach the arm prompts.

To attach mounting bracket:

Figure 8a:

1. Loosen the top two knobs (A) on the body support of the Mobile Stander.
2. Slide the slotted mounting bracket (B) behind the knobs and tighten them securely.
3. Arm prompts, hand loops and/or the communication tray can now be attached.

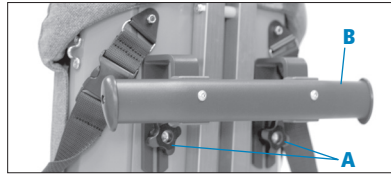

Figure 8a



Figure 8b

To attach arm prompts:

1. **Figure 8b:** Loosen the clamp knob (C) and pull it down to free the curved metal piece (D).
2. **Figure 8c:** Slip the clamp over the oval tube of the mounting bracket with the white adjustment button (E) to the outside of the mounting bracket.
3. Close the curved metal piece, pull the knob up, and tighten it securely.

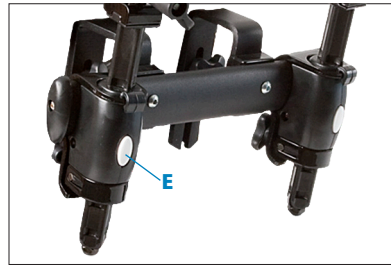

Figure 8c

Tip: To benefit from the full range of adjustment of the arm prompts, removing the large wheels while the prompts are in use is recommended.

Adjustments:

Figure 9a:

Use knob (D) to adjust arm prompt sideways, forward or backwards, for elbow rotation, and to angle up or down.

Use knob (E) to rotate the handhold or adjust it in and out.

To position arm prompt further forward press the clamp button (F) and remove the post. Next, loosen knob (C) and remove the clamp from the mounting bracket. Turn the clamp around and remount it with its knob to the inside. Slide the arm prompt back into the clamp.

Press button (F) to adjust the height of arm prompt post. Release button to engage into desired position.

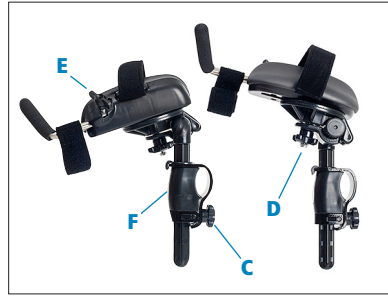

Figure 9a

Hand loops with mounting bracket

Recommended use

The hand loops give additional support for a client with poor head and/or shoulder control. They stimulate the client to raise his/her head. The mounting bracket is needed to attach the hand loops on the Mobile Stander.

Attaching mounting bracket

See instructions for installation of mounting bracket on page 8 (see Figure 8a).

Figure 10a:

To attach hand loops:

1. Loosen the clamp knob (C) and pull it down to free the curved metal piece.
2. Slip the clamp over the oval tube of the mounting bracket with the white adjustment button (F) to the outside of the mounting bracket.
3. Close the curved metal piece, pull the knob up, and tighten it securely (also see Figures 8b and 8c).

Adjustments:

1. Loosen knob (C) to completely remove hand loop from mounting bracket.
2. Loosen knob (D) to tilt the hand loop to desired position. Tighten knob securely.
3. Press button (F) to adjust the height of hand loop. Slide post up or down to desired position. Release button to engage into desired position.

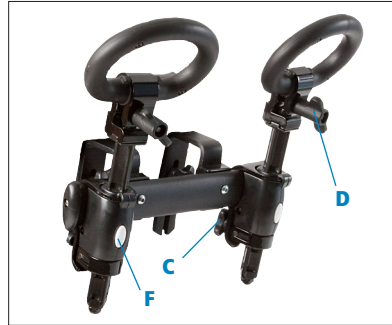

Figure 10a



Figure 10b

Communication tray with mounting bracket

Recommended use

WARNING To prevent injury, do not use the communication tray as a restraint or for body support.

NOTICE The Rifton communication tray is intended for use on the Rifton Mobile Stander only.

The communication tray provides a surface for personal communication devices and for other activities. Communication sheets can be placed under the false bottom and electronic devices can be secured to the tray. The tray can easily be removed when not needed.

Installation of communication tray:

The same mounting bracket used for hand loops or arm prompts can also accommodate a tray for manipulative activities and communication devices (see mounting bracket installation instructions on page 8).



Figure 11a

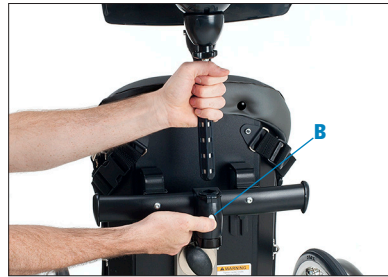

Figure 11b

Figures 11a and 11b:

1. Loosen the clamp knob (C) and pull it down to free the curved metal piece (A).
2. Slip the clamp over the oval tube of the mounting bracket with the white adjustment button (B) to the outside of the mounting bracket.
3. Close the curved metal piece, pull the knob up, and tighten it securely (also see Figure 8b).

Adjustments

To adjust the tray:

Figures 12a and 12b:

1. Loosen knob (A) to change the tilt angle of tray or to rotate the tray from side to side.
2. To adjust the height or completely remove the tray, press button (B), slide post to the desired position and release button (B).
3. The tray insert can be removed by pressing upward through the holes in the back of the tray. Reinstall insert by placing tabs in slots at the bottom of tray. Then press down on front top edge of insert until it snaps in place.



Figure 12a

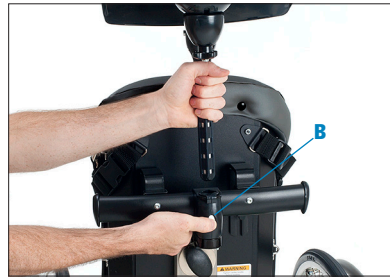

Figure 12b

Operation

WARNING

To prevent falls and injuries:

- **Immobilize the product by applying the wheel locks before placing a client into or removing a client from the Mobile Stander.**

- **When removing the client from the stander, ensure that the client is sufficiently supported as straps are being released. Begin by releasing straps from the feet and work upwards.**

1. To safely place a client in the Mobile Stander, immobilize the unit by applying the wheel locks.
2. Release snap hooks or buckles on one side of seat pad and center strap of seat pad, allowing seat pad to swing out of the way.
3. Release one side of top strap and swing it out of the way.
4. Carefully place the client into the stander from the back.
5. The seat pad should be placed under the client's buttocks. If the client is non-weight-bearing, position it at an angle appropriate to bear the client's weight. If the client is weight-bearing, the pad should be positioned vertically.
6. The top strap, with fleece in back, should be placed under the client's arms and fastened behind the client's back.
7. After placing the client in the unit, review the following checklist:
 - Is the bottom of the body support below the knees?
 - Is the top of the body support about nipple level or lower?

- Are the feet placed under the hips and as far forward on the platform as possible without causing discomfort?
 - Is the body properly aligned?
 - Is the body support adjusted to the proper width?
 - Are all the straps fastened and snug?
 - Is the client free of discomfort?
8. When removing the client from the stander, ensure that the client is sufficiently supported as straps are being released. Begin by releasing straps from the feet and work upwards.

Maintenance

This product is designed and tested for an expected life of 5 years when used and maintained in accordance with this manual. At all times, users must ensure that the product remains in a safe and useable condition, including regular maintenance and inspections as specified in the manual.

To prevent structural failure, which may result in serious injury or death:

- Inspect this product and components regularly for loose or missing screws, metal fatigue, cracks, broken welds, missing attachments, general instability or other signs of excessive wear.
- Immediately remove this product from use when any condition develops that might make operation unsafe.
- Do not use Rifton components or products for any purpose other than their intended use.
- Replace or repair components or products that are damaged or appear to be unstable.
- Use only Rifton authorized replacement parts. Order information for replacement parts is provided on the back of this product manual.

Twice a year, perform the following maintenance:

- Apply a drop of oil to the caster bearings and wheel axle.
- Inspect all nuts. Tighten if necessary.
- Inspect strap stitching and replace if they become frayed.

Cleaning

Clean with disinfectant wipes or a solution of up to 10% bleach. Do not use excessive amounts of water.

The fleece sleeve can be removed for laundering. Do not iron.

Warranty Statement

If a Rifton product breaks or fails in service during the first year, we will replace it free of charge.

Materials

- Steel hardware items (nuts, bolts, screws, etc) are typically zinc or nickel plated, or stainless steel.
- Upholstery items (pads, support blocks, padded prompts, etc) are typically polyurethane foam with a fire-retardant cover made from expanded vinyl.
- Frames are typically steel or aluminum tubing, welded together, and coated with a baked-on paint finish. Some frame components may also be stainless steel.
- Tires are tubeless, filled with polyurethane foam, and do not require inflation.
- Straps are typically made of polypropylene or nylon webbing.
- Plastic components are typically injection molded from a variety of industrial resins.

All materials are latex, lead and phthalates free.

User modifications

 WARNING To prevent serious injury or death, do not modify or alter Rifton products or components, or use Rifton products or components in conjunction with products from other manufacturers. Rifton does not accept responsibility for any modifications or alterations made to our components or products after they leave our premises. Customers modifying or altering our components or products, or using them in conjunction with products from other manufacturers, do so at their own risk.

Rifton Contact Information



Email

sales@rifton.com



Phone

800.571.8198
9–5 EST



Mail

Rifton Equipment
PO Box 260
Rifton NY 12471–0260



Fax

800.865.4674



Online

www.rifton.com

To order replacement parts

1. **Locate the ID number** of the product on the small white label.
2. Have this number available when you call **800.571.8198** for your customer service representative.

Use only replacement parts supplied by Rifton Equipment.

We are glad to supply replacement parts. Although Rifton makes every effort to supply correct parts and instructions for repairing or refurbishing your equipment, you are responsible to make sure that the repairs or modifications are correctly and safely completed.



Find letters of medical necessity
and informative articles at:

www.rifton.com/mobilestander